

See discussions, stats, and author profiles for this publication at: <https://www.researchgate.net/publication/26493010>

Folding instabilities and cracking of thin coatings on a soft polymer substrate as a model of the oceanic crust

Article in *Geofisica Internacional* · January 2001

Source: DOAJ

CITATIONS

5

READS

31

2 authors, including:



Sergey Bazhenov

Semenov Institute of Chemical Physics

259 PUBLICATIONS 1,495 CITATIONS

SEE PROFILE

Some of the authors of this publication are also working on these related projects:



Self-oscillating neck propagation in polymers [View project](#)



Cold rolling [View project](#)

2001

A. L. Volynskii / S. L. Bazhenov

FOLDING INSTABILITIES AND CRACKING OF THIN COATINGS ON A SOFT
POLYMER SUBSTRATE AS A MODEL OF THE OCEANIC CRUST

Geofísica Internacional, april-june, año/vol. 40, número 002

Universidad Nacional Autónoma de México

Distrito Federal, México

pp. 87-95

Folding instabilities and cracking of thin coatings on a soft polymer substrate as a model of the oceanic crust

A. L. Volynskii¹ and S. L. Bazhenov²

¹ Faculty of Chemistry, Moscow State University, Moscow, Russia

² Semenov Institute of Chemical Physics, Russian Academy of Sciences, Moscow, Russia

Received: September 21, 2000; accepted: January 29, 2001.

RESUMEN

Se presentan resultados experimentales sobre fractura tensional de capas delgadas metálicas sobre una base sintética. La geometría de las fracturas presenta analogías con el relieve del fondo marino en regiones de extensión.

PALABRAS CLAVE: Tectónica experimental, fractura tensional.

ABSTRACT

Nucleation and development of microrelief and fragmentation of coating under tensile extension of polymer films coated with a thin rigid layer is studied, and the mechanisms responsible for the development of both types of structures are discussed. The development of regular folding is controlled by compression-induced buckling instabilities in a rigid coating on a compliant support. Parallel cracks are due to features of mechanical stress transfer from a soft substratum to a rigid coating via an interface. Micro-relief is similar to relief of the oceanic floor in the vicinity of mid-oceanic ridges. We suggest that the young oceanic crust and the upper mantle may behave as a solid coating on a soft basement system.

KEY WORDS: Experimental tectonics, tensional fracture.

INTRODUCTION

The areas adjacent to ocean ridges are the youngest regions of the Earth's crust. These regions are characterized by a relief with a peculiar structure. Figure 1 shows a segment of the map of the northwestern Pacific (Heezen and Tharp, 1977). The ocean floor shows a wavy relief with regular transform faults in the direction of spreading.

The process of relief generation may be controlled by several factors, which are common to a solid coating on a soft substrate. In nature, such systems are quite common, e.g., fruit and vegetables, human bodies and bodies of animals and, possibly, the Earth itself.

We report an experimental investigation of model experiments to study the conditions prevailing during the generation of surface relief similar to that of the ocean floor.

EXPERIMENTAL WORK

Commercial films of amorphous unoriented poly (ethylene terephthalate) (PET), poly (vinyl chloride) (PVC), synthetic isoprene rubber (IR) and natural rubber (NR) were used as a substrate. The thickness of PET and rubber substrates

was 100 μm and 500 μm respectively. The rubber was cross-linked with 1.5 weight parts of dicumyl peroxide per 100 weight parts of raw rubber. Dumbbell - shaped samples were cut from the polymer film. The size of the specimens was 6 \times 22 mm. The surface of the test samples was coated with a thin layer of gold, platinum or quartz up to 15 nm in thickness, using ionic-plasma or thermal deposition. The coating was approximately 20 000 times thinner than the rubber substrate. Next, the test samples were elongated in an Instron-4301 testing machine (Figure 2). A loading rate of 1 to 500 mm/min was applied, and the temperature of elongation was varied from room temperature to 105°C.

The method of loading depended on the polymer substrate. Coated thermoplastic polymers (PET or PVC) were elongated at temperatures exceeding the glass transition temperature T_g (75°C for PET and 65°C for PVC). Above T_g the polymers are soft and their mechanical properties are similar to that of rubber. After elongation, coated samples were cooled to room temperature without removing from the test machine. Cooling of the samples in the elongated state prevented recovery of the original length after unloading.

The coated rubber samples were elongated at room temperature. To avoid recovery after unloading, the length was fixed with special clamps. To study behavior under compres-



a

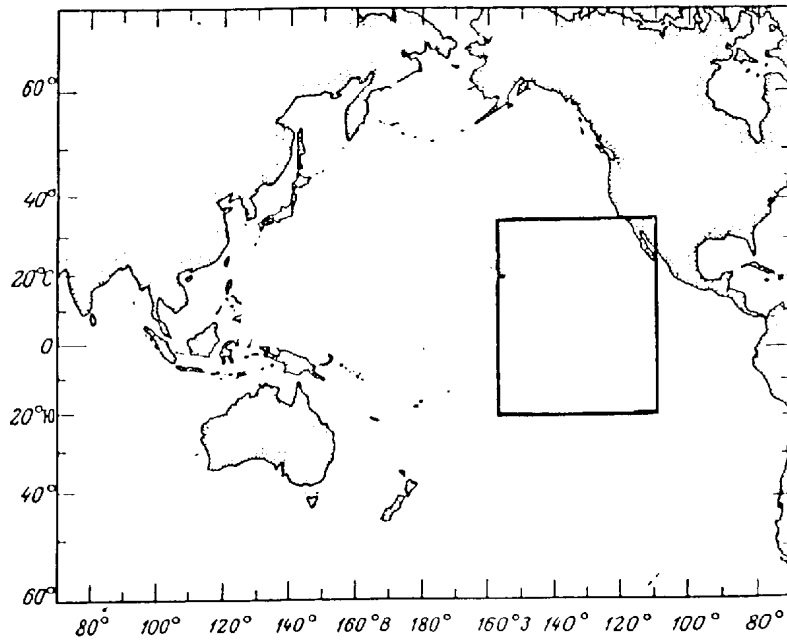

b

Fig. 1. Ocean floor relief in the region of the Mid Ocean Rise (a) and its location in the Pacific Ocean (b).

sion, uncoated rubber was elongated, coated by a platinum film in the elongated state, and released from the clamps. After unloading, the rubber shrank to its initial size, and the coating was compressed due to rubber shrinkage.

The surface of samples was studied on a Hitachi S-520 scanning electron microscope (SEM). Profiles of the coated surfaces were observed under a Nanoscope atomic-force microscope (AFM) by digital instruments. The probe to sample

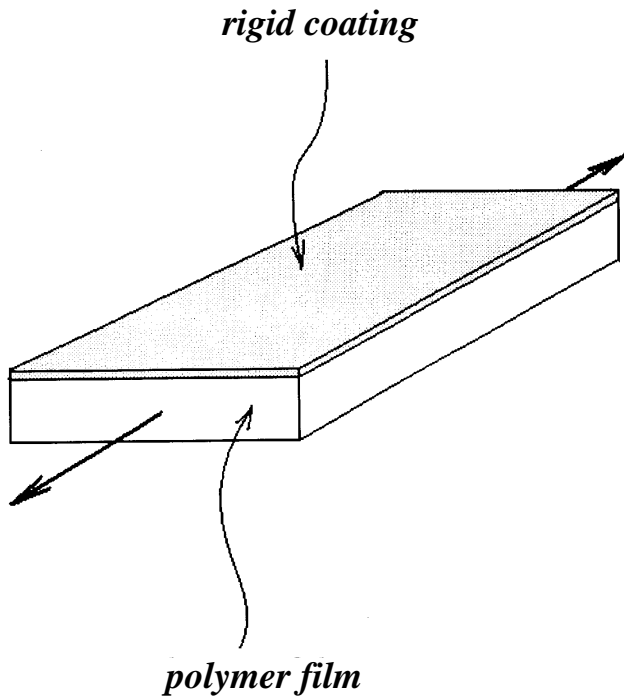

Fig. 2. Schematic representation of the equipment used by Volynskii A.L. *et al.*, 1999, 2000.

interaction was maintained constant at a level of 10^{-9} N under the scanning regime. The thickness of the platinum layer was changed by changing the time of deposition. To measure the thickness of coating, Pt was deposited on a smooth glass surface. The coating was scratched, and the depth of the scratch was measured under an atomic-force microscope. The thickness of the coating was found to be proportional to time of deposition. The experimental coefficient of proportionality was used in determination of the thickness of the deposited platinum layer.

RESULTS AND DISCUSSION

Figures 3a-c show scanning electron microscope (SEM) images of different composites after elongation. Dark and light bands, perpendicular to the direction of the elongation, are observed on the photographs. Dark bands are cracks in the coating, and light bands are fragments of the fractured coating. The deformed coating forms a regular pattern. Grooves and ridges in the micro-relief are oriented strictly along the tension axis. The polymer substrates are quite different: PVC is a ductile polymer, PET is liquid-like, and SR and NR are elastic polymers. Yet similar surface patterns are observed in all experiments. Coating cracks along bands oriented perpendicularly to the direction of the applied stress, and a regular wave-like microrelief appears on the originally plane surface.

Figure 4a shows atomic force image of a surface sample similar to that in Figure 3. Figure 4b shows the profile of the

coating surface along the dotted line in Figure 4a. The profile of the coating relief is wavy. The amplitude of the wave is $\sim 1.4 \mu\text{m}$, and the period is $\sim 2.0 \mu\text{m}$.

Surface patterns in the coated polymers are quite similar to the ocean floor relief (Figure 1). The faults are analogous to cracks, and the periodic ridges are analogous to folds. This suggests similar structures in the model samples and in the Earth's lithosphere: both involve a soft substrate coated with a thin rigid film.

Volynskii *et al.* (2000) showed that structures similar to those in Figure 3 may also be obtained when polymer film is stretched, and the surface of the film is coated with a thin rigid layer. When the sample is unloaded it recovers to its initial length. Figures 5a and 5b compare the microscopic images of specimens of synthetic rubber prepared by both procedures.

In both cases, a similarity of microrelief structure is observed which suggests a common mechanism. Despite a general similarity between Figures 5a and 5b, there is an important difference between them concerning the orientation of microreliefs with respect to the tension direction. The microrelief produced by direct tension (Figure 5a) is oriented along the extensional axis, and the microrelief produced by the contraction of the sample is oriented perpendicular to the extensional axis (Figure 5b). This difference may be related to the compression of a rigid coating in a direction which is needed for the development of a wavy relief. The volume of rubbery polymers in tension remains practically constant. Deformation is accompanied by a major lateral contraction, which compresses the coating in the direction perpendicular to the tensile elongation. When the sample shrinks the direction of compression coincides with the direction of the preceding tension. Therefore, the microrelief is shifted by 90° with respect to the direction of extension. Thus the development of a regular microrelief is always due to compression of a solid coating layer on a soft substratum.

The role of compression is crucial to explanation of this phenomenon. Consider some early observations of compression of elongated solid bodies. Such phenomena were considered by Euler more than 200 years ago. He showed that, under compression, an elastic rod buckles when a critical stress is attained (Figures 6a and 6b). The rod acquires a wavy shape and the wavelength is equal to twice the length of the compressed body (Feynman, 1964). When the rod is firmly attached to a soft elastic substrate (Figure 6c), the behavior under compression is quite different. At the critical compression stress, the rod cannot buckle (Figure 4d) because of the restoring force from the support which is proportional to the deflection. Because of interaction between the applied force and the resistance from the support, a coating will adopt a sinusoidal shape with wavelength λ .

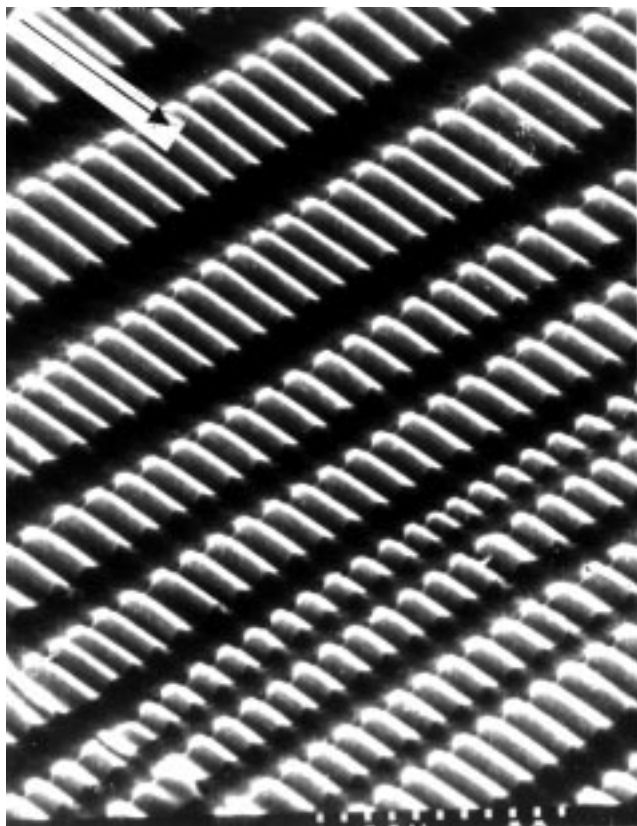

a 30 μm

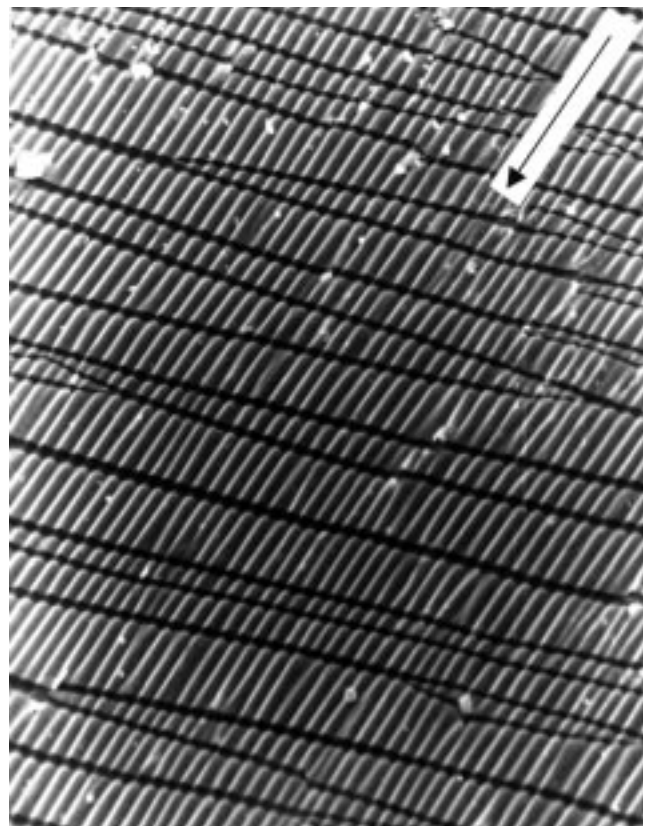

b 100 μm

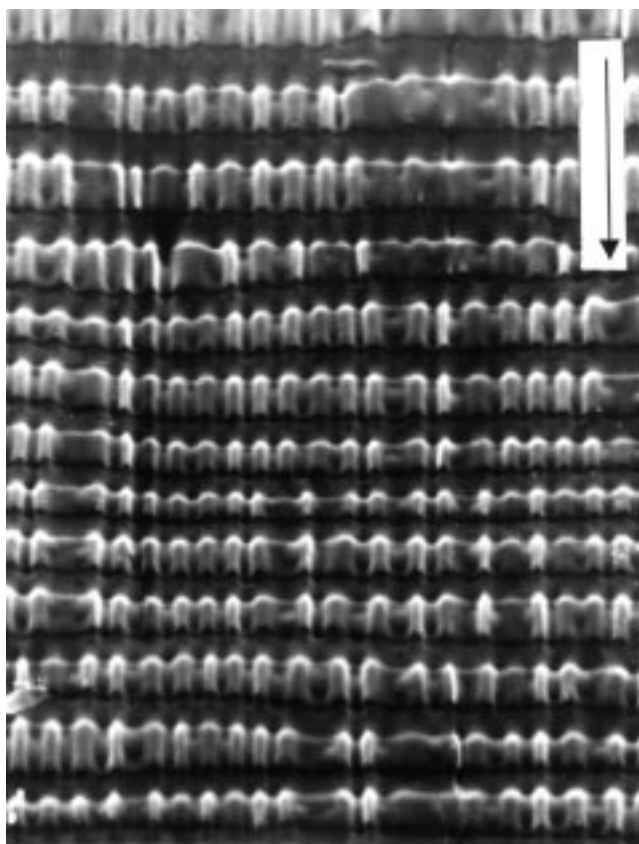

c

Fig. 3. SEM images of (a) - platinum-coated (20nm) PVC after deformation to a strain of 100% at 90°C; (b) gold-coated (15nm) NR after deformation to a strain of 100% at room temperature; (c) quartz-coated (15nm) PET after deformation to a strain of 100% at 85°C. The direction of tensile stress is shown by arrows.

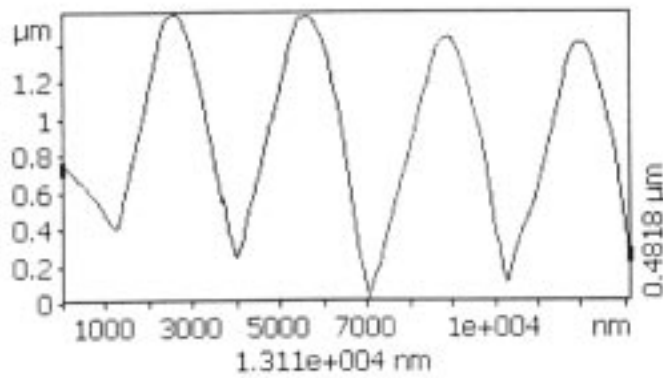
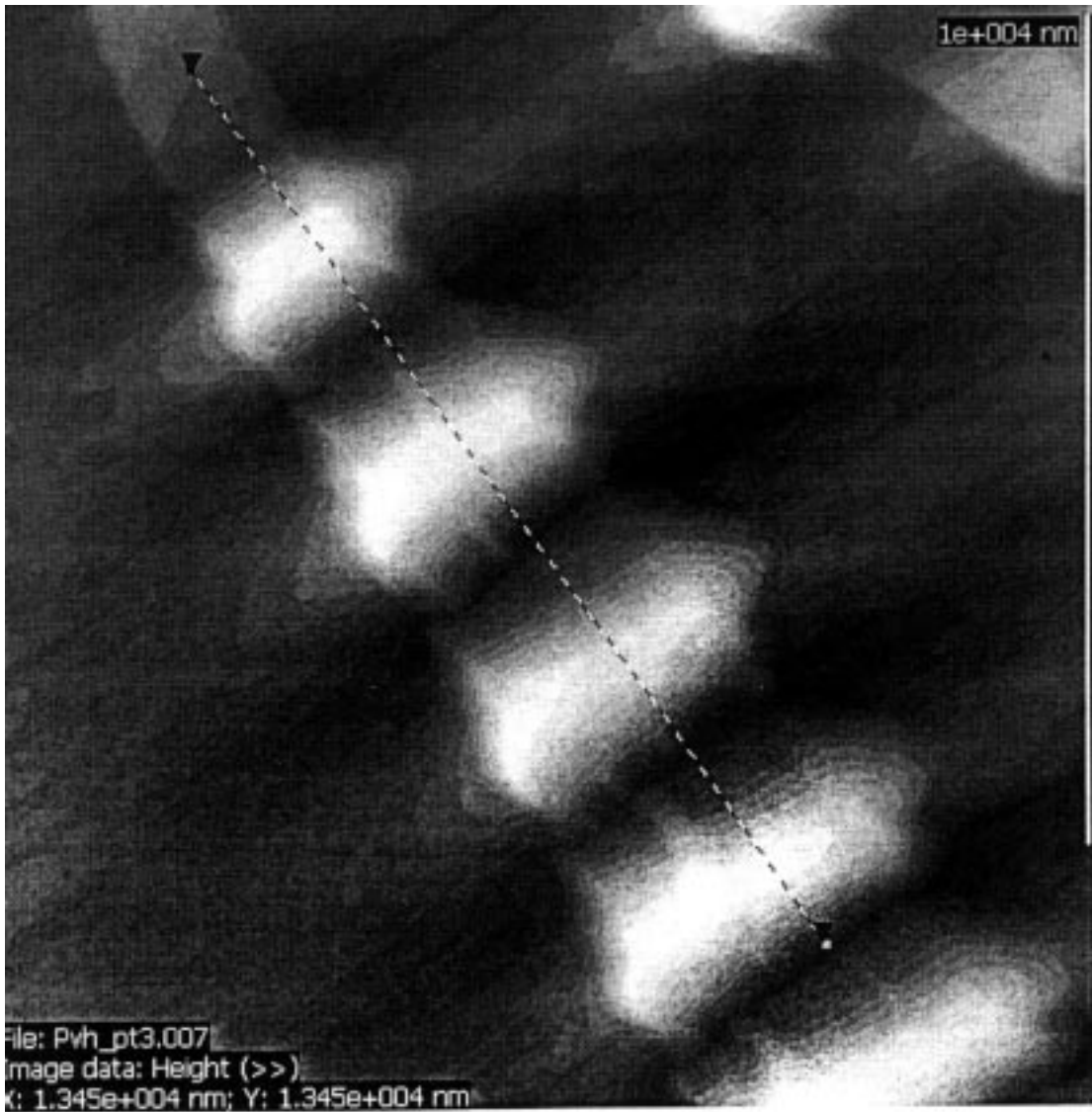

Fig. 4. a) AFM image of a surface of platinum-coated (20nm) PVC after elongation to a strain of 100% at 90°C; b) topographical AFM image of a sample shown in Figure 4a along dotted line

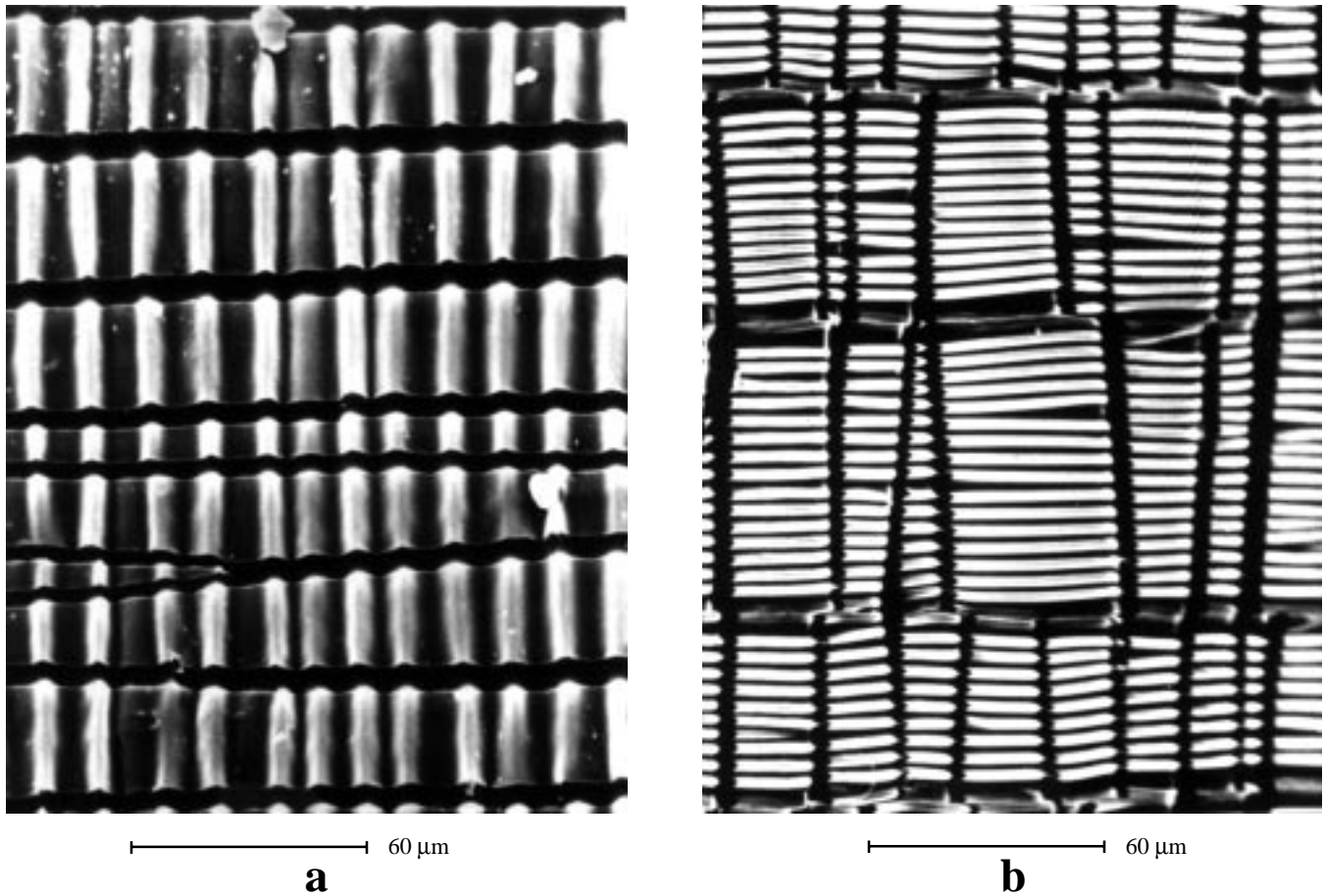

Fig. 5. SEM images of IR samples coated with a thin platinum layer with a thickness of 15 nm: (a) deformation is carried out for the Pt-coated sample to a strain of 100%; (b) initial IR sample is drawn to a strain of 100%, coated with Pt layer and allowed to shrink and recover its initial size. The direction of tensile stress is vertical.

Buckling under compression was discussed by Smoluchowski (1909, 1910). Later on, the problem was worked out by Biot (1954, 1959, 1965) and Ramberg (1963, 1964). They showed that a solid coating should bend under compressive stresses and gravity. We tested this mechanism of formation of relief. Figure 7 shows experimental design used by Ramberg and Stephansson (1964). A stress is applied to an elastic coating (rubber or gelatin plate) floating on a dense, low-viscosity liquid (mercury, saturated solution of KI). Under these conditions no cracking of the coating takes place. In our experimental approach we are able to study cracking of the coating layer as in the development of the Earth's crust, which the earlier model procedure (see Ramberg, 1964, Figure 7) is unable to do as low-viscosity substrates were used. These substrates were unable to transfer enough stress to the coating. Furthermore, the stress was applied to the coating unlike real processes in nature. The microrelief shown in Figure 3 is produced by deformation of the polymer support, a soft substratum. All morphological features, which are typical of the formed relief, were associated with the transfer of mechanical stress from the soft substrate to the rigid coating.

Consider the process of regular cracking in more detail. As shown in Volynskii *et al.* (1999, 2000), regular fragmentation of a rigid coating is due to specific features of the mechanical stress transfer from a soft substratum to a rigid coating via an interface. As the coating fractures, the stress distribution in the fractured surface of the polymer film is highly nonuniform. At the edges of the fragment, the stress is equal to zero; but away from the edges of the fragment, stress increases because the coating is attached to the polymer support. In any fragment, maximum stress is found at the center, that is, at the farthest point from the edges. With further extension of the polymer support, stress in the coating increases but its distribution remains unchanged; at the edges of a fragment, stress is still equal to zero. Finally, the stress at the center of the fragment reaches the strength and the fragment breaks in two new fragments with similar dimensions. This mechanism of fracture was analytically discussed by Volynskii *et al.*, (1999). They showed that the mean length L of the fractured fragments along the tensile axis is

$$L = 2h (\sigma^*/\sigma_0) , \quad (1)$$

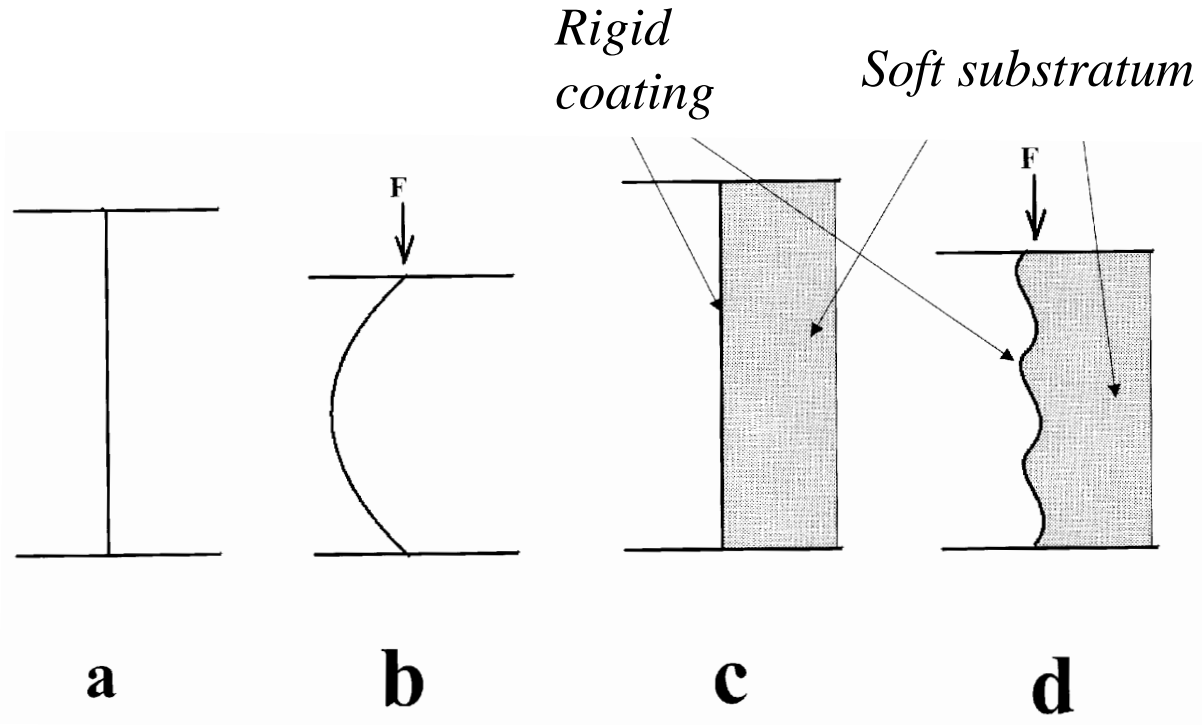

Fig. 6. Buckling instability for an anisodiametric body in a free state (a, b) and on a soft substratum (c, d).

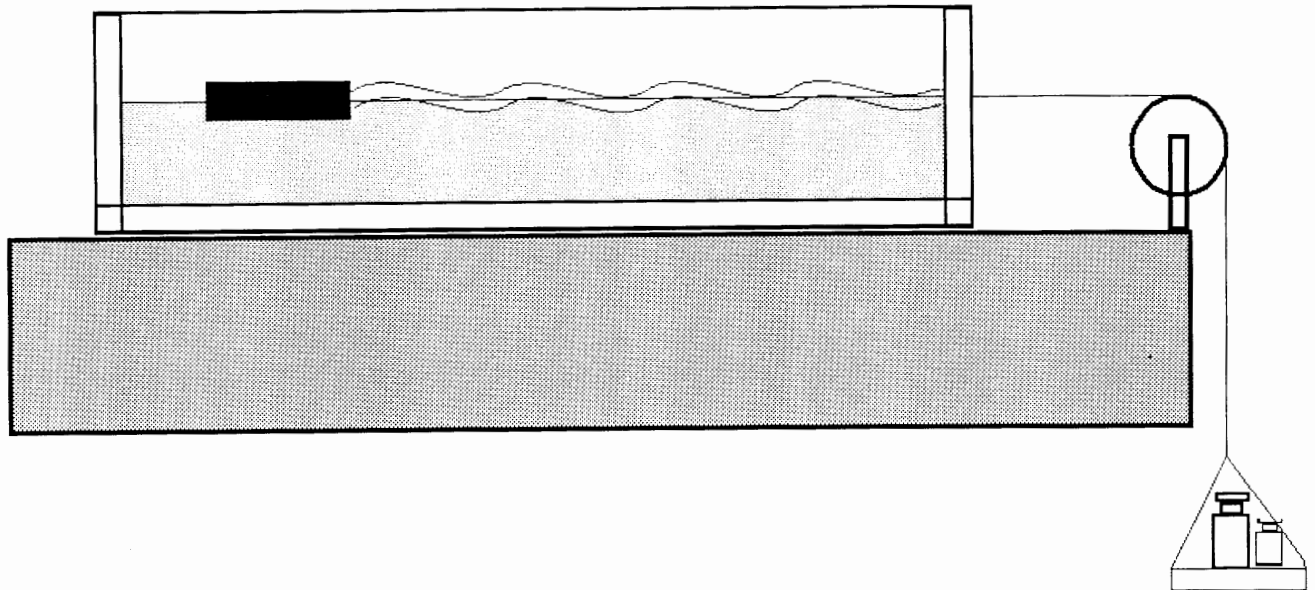

Fig. 7. Schematic representation of the equipment used for modeling of folding by Ramberg and Stephansson (1964).

where h is the thickness of coating, σ^* is the strength, and σ_0 is the stress in the support. Experimental verification of equation (1) (Volynskii *et al.*, 1999) showed a reasonable agreement with experimental data.

Electron microscopic observations provide direct evidence in support of the above mechanism of fracture. Figure 8 shows scanning electron microphotos of two samples of PET with deposited platinum coating which were stretched

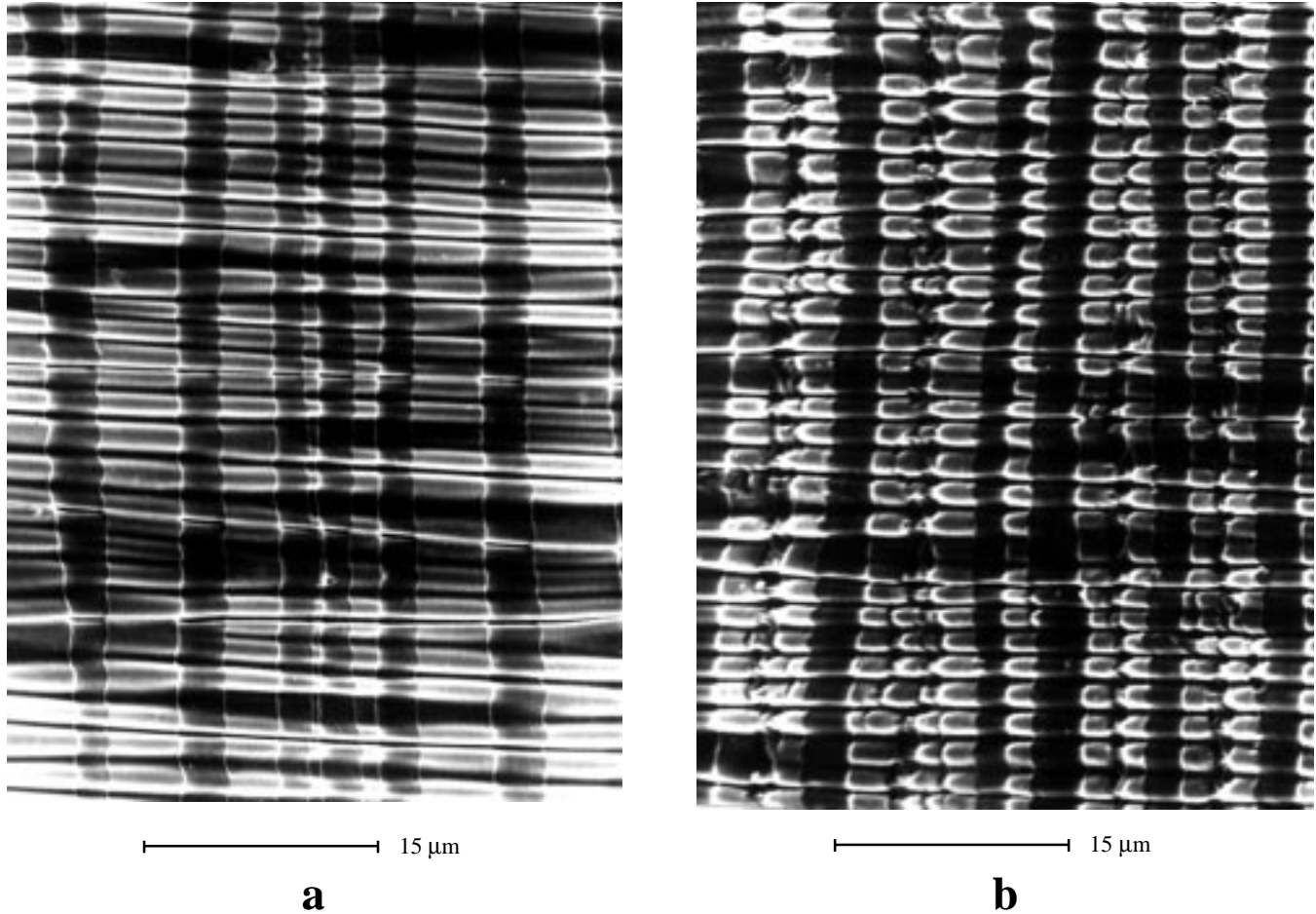

Fig. 8. SEM images of PET samples after deformation to a strain of 100% at 100°C (a) and to a strain of 50% at 100°C and then to a final strain of 100% at 80°C (b). Drawing direction is horizontal.

to a tensile strain of 100%. The first sample (Figure 8a) was stretched at 100°C. The coating breaks down into fragments with a mean width of 3.5 μm. The second sample was first stretched at 100°C to a tensile strain of 50%; then, the temperature was decreased to 80°C, and the sample was stretched to a tensile strain of 100%. Due to the temperature drop, the stress in the support increased from 0.7 to 3.5 MPa. Next fragmentation proceeds but, in this case, the mean sizes of the fractured fragments were only 1.7 μm (Figure 8b). During the second loading cycle, nearly every fragment of coating broke down exactly into two equal parts. Notice that all fragments break down sharply at the center. These features of fracture of metallic coatings agree with our hypothesis. It accounts for the regular location of cracks in the coating and with the development of fractured fragments with similar dimensions.

In conclusions, the relief shown in Figure 3 is similar to that shown in the maps of Heezen and Tharp. A comprehensive experimental and theoretical investigation of the structural-mechanical behavior of rigid coatings on a soft polymeric substratum (Volynskii *et al.*, 1999, 2000) enables

us to use direct measurements of the parameters of the formed relief for a quantitative estimation of important characteristics of such systems, such as the level and direction of the relief-forming stress at support, the strength and the yield stress of the coating, the thickness of coating and others.

We suggest a striking similarity in the morphology of the oceanic crust and our model systems. The oceanic crust of the Earth may be modeled as a rigid coating on a soft substratum.

BIBLIOGRAPHY

- BIOT, M. A., 1954. Theory of Stress-Strain Relations in Anisotropic Viscoelasticity and Relaxation Phenomena. *J. Appl. Phys.*, 25, 11, 2133-2161.
- BIOT, M. A., 1959. Folding Instability of a Layered Viscoelastic Medium Derived from an Exact Stability Theory of a Continuum under Initial Stress. *Quart. Appl. Math.*, 17, 1231, 722-743.

- BIOT, M. A., 1965. *Mechanics of Incremental Deformations*. Wiley. New-York.
- FEYNMAN, R. P., R. B. LEIGHTON and M. SANDS, 1964. *The Feynman Lectures on Physics*. V.2. Addison - Wesley Publishing Company, Inc. London.
- HEEZEN, B. C. and M. THARP, 1977. *World Ocean Floor*, US Navy, Office Naval Research.
- RAMBERG, H., 1963. Fluid Dynamics of Viscous Buckling Applicable to Folding of Layered Rocks. *Bull. Am. Assoc. Petrol. Geologists*, 47, 484-507.
- RAMBERG, H., 1964. Selective Buckling of Composite Layers with Contrasted Rheological Properties. *Tectonophysics*, 9, 307-332.
- RAMBERG, H. and O. STEPHANSSON, 1964. Compression of Floating Elastic and Viscous Plates Affected by Gravity. *Tectonophysics*, 1, 101-127.
- SMOLUCHOWSKII, M., 1909. Über ein gewisses Stabilitätsproblem der Elastizitätslehre und dessen Beziehung zur Entstehung von Faltengebirgen. *Abhandl. Akad. Wiss. Krakau, Math.*, K1, 3.
- SMOLUCHOWSKII, M., 1910. Versuche über Faltungerscheinungen und Schwimmen der Elastischer Platten. *Abhandl. Akad. Wiss. Krakau, Math.*, K1, 727.
- VOLYNSKII, A. L., S. L. BAZHENOV, O. V. LEBEDEVA, A. N. OZERIN and N. F. BAKEEV, 1999. Multiple Cracking of Rigid Platinum Film Covering Polymer Substrate. *J. Appl. Polymer Sci.*, 72, 1267-1275.
- VOLYNSKII, A. L., S. L. BAZHENOV, O. V. LEBEDEVA and N. F. BAKEEV, 2000. Mechanical Buckling Instability of Thin Coatings Deposited on Soft Polymer Substrates. *J. Mater. Sci.*, 35, 547-554.
-
- A. L. Volynskii¹ and S. L. Bazhenov²
¹ Faculty of Chemistry, Moscow State University, Vorob'evy gory, Moscow, 119899 Russia
² Semenov Institute of Chemical Physics, Russian Academy of Sciences, ul. Kosygina 4, Moscow, 117977 Russia
Fax: +7 (095) 9390174
Email: volynskii@mail.ru